

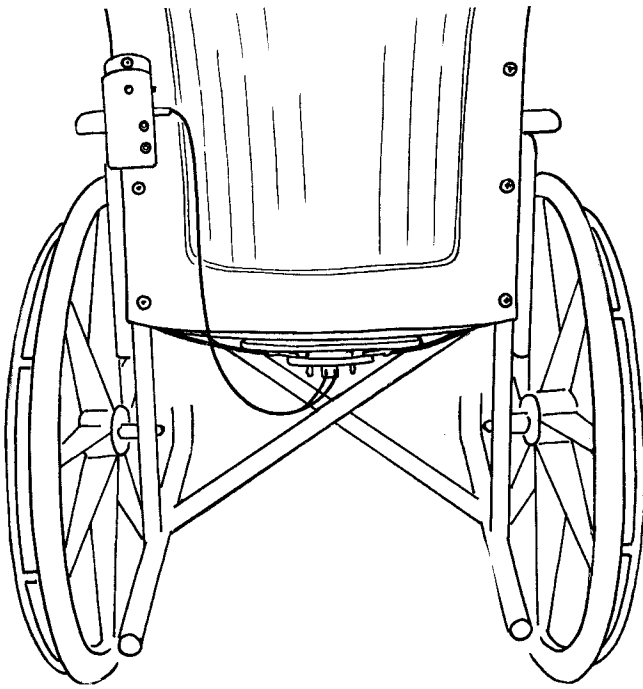

ChairPro™ UNDERSEAT WHEELCHAIR ALARM



Model #	Fits Wheelchairs	Unit
909369	16" to 22"	Each

This effective new alarm does away with sensor strips and clothing clips. Skil-Care's ChairPro UnderSeat Wheelchair Alarm features a sensor that mounts under the seat where it is protected against wear and incontinence. Replacement guaranteed for one full year, the ChairPro UnderSeat Wheelchair Alarm eliminates the cost of having to buy expensive, frequently replaced sensor strips. The ChairPro UnderSeat Wheelchair Alarm may be used with or without a cushion.

PURPOSE

Skil-Care's ChairPro UnderSeat Wheelchair Alarm alerts caregivers when a resident/patient has left or fallen from the wheelchair.

CAUTIONS

1. The ChairPro UnderSeat Wheelchair Alarm is not a substitute for proper supervision. Fall-risk and wander-risk patients should be monitored regularly.
2. Check battery each time alarm is used. If weak, replace the 9-volt battery.
3. LED should flash when patient/resident is seated. If LED fails to flash, check battery.

INSTALLATION - ALARM UNIT

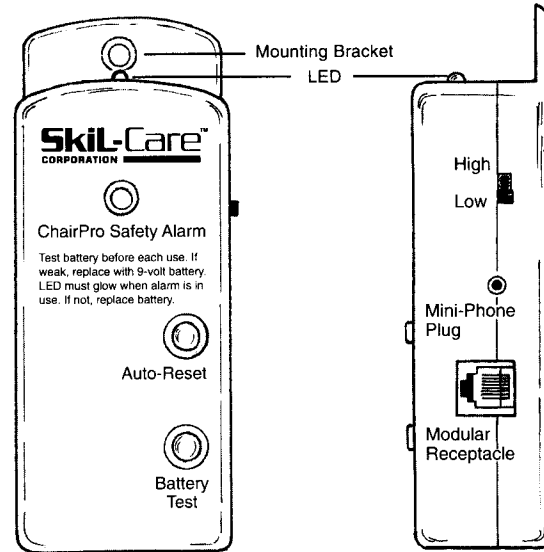

You may choose one of the following two ways to attach the alarm unit to the wheelchair.

Mounting Bracket

1. Remove the second-from-top screw from either the left or right side of the wheelchair backrest.
2. Remove grommet from screw, place the screw through hole on alarm unit mounting bracket, and fasten screw to wheelchair backrest. (Illustration A)

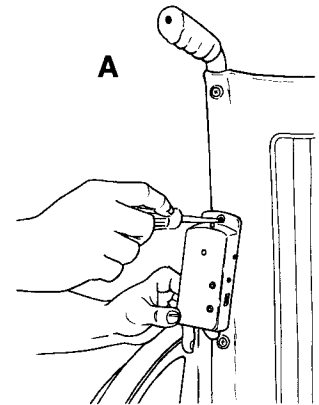

Cord Loop

1. Insert enclosed cord loop through bracket hole. (Illustration B)

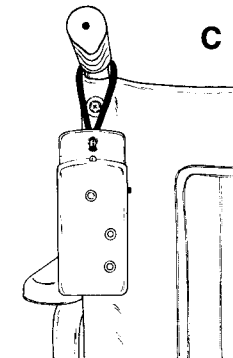
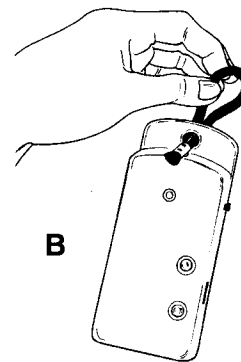

2. Hang from wheelchair push-handle. (Illustration C)

INSTALLATION-UNDERSEAT SENSOR UNIT

1. The under-seat sensor unit includes a quick-detach feature that permits the sensor to be removed easily when the wheelchair has to be power washed. (Illustration D)

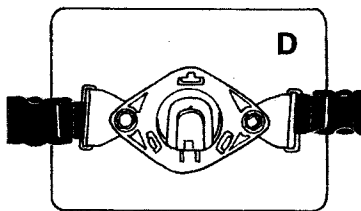

2. Remove the second and third screws on both sides of the wheelchair seat. (Illustration E)

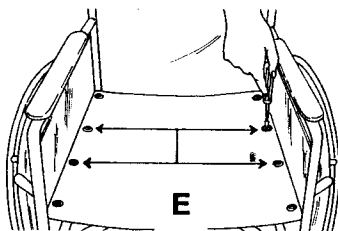

3. Disconnect the hanger straps from the sensor unit. Place the web straps with grommets between the wheelchair seat upholstery and the seat frame. Align the grommets with the screw holes. Reinsert and fully tighten the screws. The hanger straps should now be secured as shown. (Illustration F)

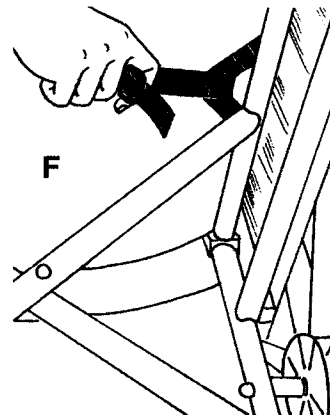

Continued on reverse side.

UNDERSEAT SENSOR UNIT

4. Connect both hanger straps to the sensor unit. (Illustration G) Make certain that the prongs on the sensor's plug are facing toward the back of the seat.

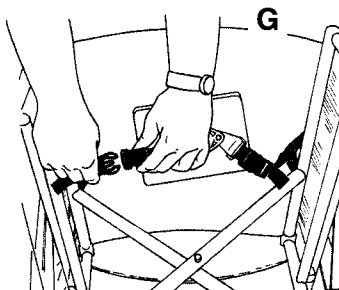

5. Pull the loose ends of both hanger straps to center the sensor and bring it into contact with the underside of the wheelchair seat. (Illustration H)

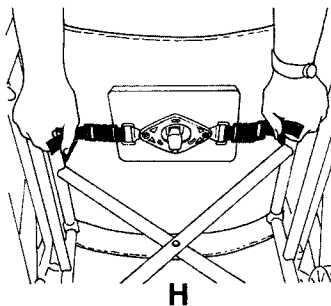

6. Attach the two spade-connectors to the under-seat sensor (Illustration I)

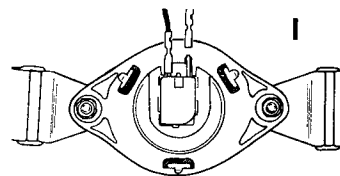

7. When installation is completed, the under-seat sensor, quick-detach feature, and power cord should appear as shown. (Illustration J)

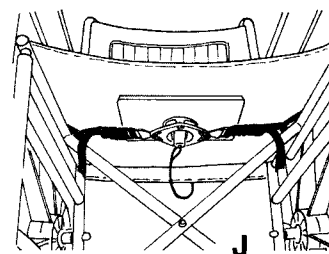

8. If you plan to use a wheelchair cushion, see #4 under "Operation" below.

OPERATION

1. Remove battery compartment cover on left side of alarm unit and install 9-volt battery.

2. Press Battery Test button. If alarm doesn't sound, check battery connection and retest. If alarm fails to sound, replace battery.

3. Insert mini-phone jack into Mini-Phone Plug receptacle on right side of alarm. (Illustration K) Alarm will sound. Press Auto-Reset to silence alarm.

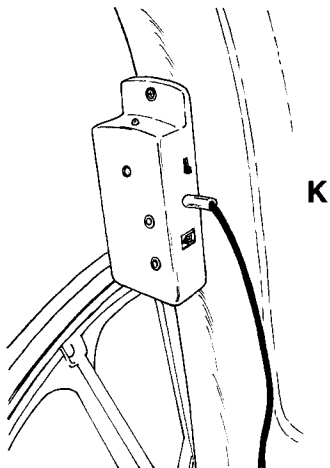

4. If a wheelchair cushion is to be used, place it on the seat for a few moments and then remove it. If the alarm does not sound, proceed to steps 5 through 7 below. If the alarm does sound, the hanger straps will have to be loosened slightly to accommodate the weight of the cushion. Loosen straps, retest with cushion, and then proceed through #7 below.

5. Before use, test the unit yourself by sitting on the wheelchair seat, rising, and then sitting again. The alarm should sound when you rise and stop when you sit down

again. Note: LED should always flash when patient/resident is seated.

6. Seat patient/resident in wheelchair. The LED will flash. If it doesn't, the sensor is probably not in contact with sling seat. See item #4 under installation of under-seat sensor unit above.

7. Select High or Low alarm volume using the switch on the right side of alarm unit.

8. If alarm is activated and patient/resident has not returned to chair, the alarm can be silenced by pressing the "Auto-Reset" button. The alarm is now in stand-by mode and ready for use. Alarm will automatically reset itself when patient/resident is again seated in chair. There is no On/Off switch.

Important: The alarm unit and under-seat sensor must be removed from the wheelchair when it is to be power-washed. Detach the under-seat sensor as shown. (Illustration L) After washing, reattach and test the system as described above.

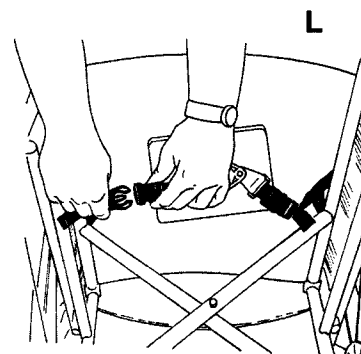

SAFETY REMINDERS

1. Check battery before each use. If alarm is weak or fails to sound, replace 9-volt battery.
2. When alarm is in use, check LED regularly. If it is not flashing, replace battery. If LED still fails to flash, check under-seat sensor to make certain that it is in contact with underside of seat.

GUARANTEE

The alarm unit and under-seat sensor are replacement guaranteed against defects in materials and workmanship under conditions of normal use for a period of one year from date of purchase. Please return defective part to dealer from whom the system was purchased. The dealer will send the defective part to Skil-Care and arrange for shipment of a replacement. This guarantee does not cover the battery supplied with the unit.

Skil-CareTM
CORPORATION

*Advanced design for nursing and therapy.*TM

Alarm unit made in China. Under-seat sensor made in USA.

Visit us online
at Skil-Care.com